



**ESHOOTER**

**FLARE M BT**

Tracer Unit

# User Manual

V1.0



V700

## Product Overview

Dear customers,

Thanks for purchasing our FLARE. In order to help you know how to use it better, please kindly read this manual before using and remember to keep it well.

Package include: 1 x Flare M Tracer Unit, 1 x Adaptor(M14-CCW to M11+CW), 1 x Type C Charging Cable, 1 x Allen Wrench (Support white BBs/Green tracer BBs/Gel BBs)  
White BBs have better showing in Rainbow mode.

### Tracer Introduction:

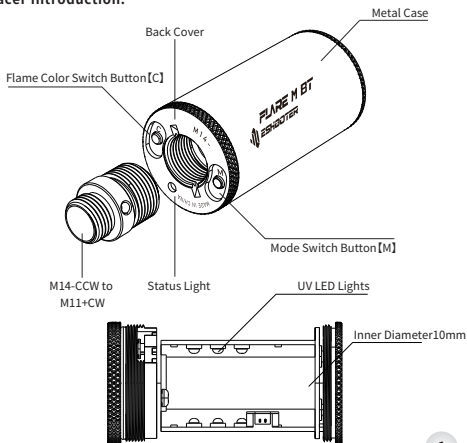

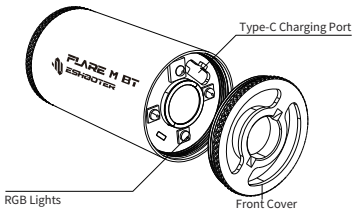

## Product Specification

Product Model	V700	Rated Input	5V = 0.5A
Size	54 x 28 mm (LxD)	Standby Current	<6 $\mu$ A
Weight	40 g	Working Current	<800mA
Case Material	Metal	Usage time	$\leq$ 6h
Temperature Range	-20°C ~ 60°C	Standby time	$\geq$ 3Months
Battery Capacity	320mAh	User Age	14+

## Instructions

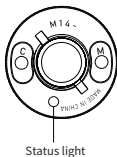













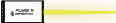





Each time the mode switching button [M] is pressed, a function is switched, and the 4 modes are cycled in turn.

Status light	Mode	Status
●	Flame	
●	Tracer with flame	
●	Tracer	
○	Drag Light	
● Twinkle twice	Turn OFF	

Each time you press the color switching button [C] to switch a new color  
10 colors cycle through

Note: Do not look directly at the RGB lamp beads when switching colors

RGB Lights	Function Description	Display State
	Displays current color when mode is switched to FLAME or TRACER with FLAME	
		
		
		
		
		
		
		
	Displays rainbow when mode is switched to FLAME or TRACER with FLAME	
	Displays 8 colors cycle when mode is switched to FLAME or TRACER with FLAME	

## Product Notice

### Sleep&Active

If the FLARE is not work for 5 minutes, it will automatically go to sleep, and shake the product to activate the device again. (Active shutdown cannot be activated by shaking)

### Charge

The Type-C charging port only supports DC 5V power supply ,Please use a regular mobile phone charger or power bank to charge ; When charging, the red light is always on. When fully charged, the green light is always on. It takes about 2 hours to fully charge.

### Low battery warning

When the battery voltage is too low, the working indicator light will flicker red, which is a low battery alarm reminder, please charge it in time!

## Installation notes

Please make sure that the inner barrel of the gun does not exceed the barrel thread by 10mm, otherwise it will not work properly.

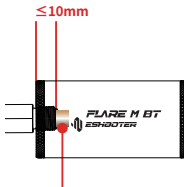

If the muzzle extends more than 5mm here it may cause the FLARE M not to work.

When installing the M11+ internal barrel pistol, you must use the M14- to M11+ adapter, and use the Allen wrench to tighten the adapter.

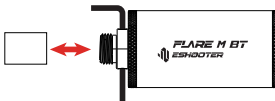

## App Instruction

1. Download and install the App  
By searching “ESHOOTER” at the App Store or google Play, you also could scan the QR code we provide

2. Connect with your device  
Make sure your device is charged and open the App, then click “FLARE M BT” and come to its interface, click the device

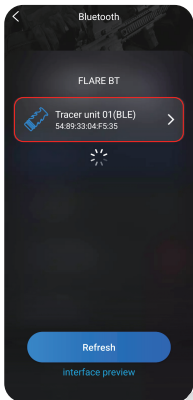
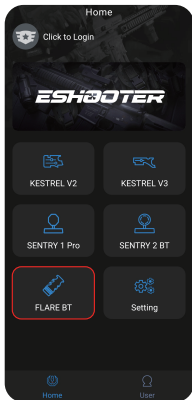

## App Interface

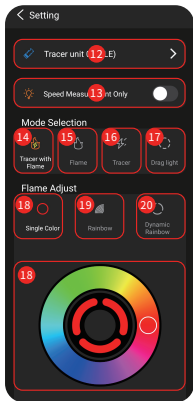
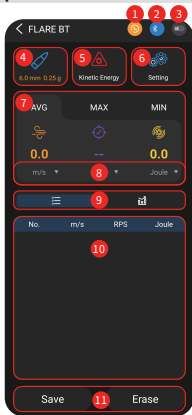

### 1 ․ History Record

Click  to check history records.

### 2 ․ Bluetooth Connection

Click  to search 'FLARE BT' and connect. If the Bluetooth signal is weak, please close to the unit and connect it.

### 3 ․ Battery Power

Check the battery power here. Please charge it in time when the battery is low.

#### 4 · BBs Options

Click  to modify diameter and weight.



#### 5 · Kinetic Energy Setting

Click  to modify the limited range of kinetic energy.



#### 6 · Tracer Setting

7 · Muzzle velocity, Rate of fire, Average kinetic energy, maximum and Minimum displayed.

8 · Muzzle velocity unit switch, ROF unit switch, Energy unit switching.

9 · Data Display and Switching.

10 · Real-time Dashboard

11 · Data saving and clearing function

12 · Bluetooth name customize

13 · Chronograph Function (Note: This function will not have tracer and flame effect after turning on.)

14 · Tracer with flame

15 · Flame

16 · Tracer

17 · Drag Light Mode

This mode can better adjust the BBs trajectory. After turn on, the BBs will be colored like your interval setting(from 1 to 10).

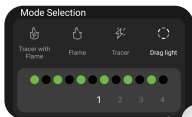



## 18 · Single Color Mode

Customize the flame color according to your setting.

## 19 · Rainbow Mode



As above, the length and color order of the rainbow can be adjusted, ranging from 0 to 80.

## 19 · Dynamic Rainbow



As above, the dynamic rainbow colors order (can be deleted or added) and time interval can be adjusted (from 0.5 to 2s).

## 21、21、Single Color Mode Recommended

## 22、Flame Brightness Adjustment

Slide the progress bar left and right to adjust the brightness of the flame.

## 23、Sensor Test Mode

Check the lights in working or not. Check that the lights are working properly.

## 24、Version

## 23、Reset

Click to reset all settings.

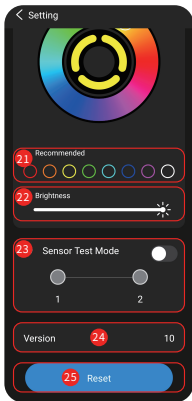

## Warning

- Please wipe the FLARE inner tube after long-term use to avoid affecting your using.
- The interior is a delicate part, please do not disassemble it by yourself
- Unable to use while charging, please unplug the power and restart
- Do not look directly at the RGB lights after powering on to avoid eyes damage!
- It is forbidden to maliciously use the transmitter to directly irradiate human eyes, and ESHOOTER will not be responsible for the damage caused by this!
- Please turn off in time when not in use. If the battery is not charged for more than 3 months, the battery may be over-discharged and its lifespan will be reduced or even damaged.
- It is forbidden to throw it into the fire, because the battery in the light emitter may explode and pollute the environment.



## Declaration of Toxic and Hazardous Substances

Parts	Toxic and Hazardous Substances or Elements					
	Plumbum (Pb)	Mercury (Hg)	Cadmium (Cd)	Chromium VI (Cr6+)	Poly- brominated biphenyls (PBB)	Poly- brominated diphenyl ethers (PBDE)
Plastic	○	○	○	○	○	○
Metal	✗	○	○	○	○	○
PCB	✗	○	○	○	○	○
Other	✗	○	○	○	○	○

○ Indicates that the content of the toxic and harmful substances in all homogeneous materials of the part is less than the requirement in SJ/T-11363-2006 《Limit requirements for toxic and harmful substances in electronic products》.

✗ Indicates that the content of the toxic or hazardous substance is at least in one homogeneous material of the part exceeds the limit requirement by SJ/T11363-2006.

This product complies with RoHS environmental protection requirements: At present, there is no mature technology in the world that can replace or reduce the lead content in electronic ceramics and copper alloys.

## Warranty Card

Name : \_\_\_\_\_

Phone Number : \_\_\_\_\_

Email : \_\_\_\_\_

Address : \_\_\_\_\_

Item Model : **FLARE M BT** \_\_\_\_\_

Inspector : \_\_\_\_\_

Date of Production : \_\_\_\_\_

## After Sale Policy

**Please keep this warranty card, purchase receipt and product packaging properly. Please present them when after sales service is requested.**

1. FLARE has 6 months warranty service since the date of purchase.
2. If there is any quality issued found under the normal operation (not man-made damaged) while the product has not been disassembled by unauthorised technicians, the product is free for replacement in the first 30 days from the date of purchase.
3. During the warranty period, if there is a quality defected be found in the normal operation, free repair service is provided after the production is inspected and verified by the authorised technicians. Warranty service does not include the transportation cost and door to door service.
4. Warranty is void under the below circumstances, free repair service is no longer provided if,
  - 4.1 User does not follow the instruction menu, mis-installation, storage and use which lead to the product failure or damage.
  - 4.2 Any damage caused by force majeure reasons.
  - 4.3 Product failure or damage caused by the disassemble or modification by the unauthorised technicians.
  - 4.4 Warranty card or purchase receipt is not provided.
  - 4.5 Warranty period is expired.
5. Warranty service would be refused to provide if there original warranty card is not presented, the repair record is not consistent with the fact, any alteration or unrecognised description on the warranty card.



RoHS



# FLARE M BT



ESHEOOTER App



[www.eshooter-world.com](http://www.eshooter-world.com)





Watch the Video

E-SHOOTER TECHNOLOGY (SHENZHEN) CO.,LTD.

 Galaxy World Phase I Tower A, No.1 Yabao Road, Longgang District, Shenzhen, China

 0086 0755 84503091

 [support@eshooter-world.com](mailto:support@eshooter-world.com)

 [www.eshooter-world.com](http://www.eshooter-world.com)



EShooter\_Tech



Eshooter\_Tech



Eshooter\_Tech



E - shooter